



650V SuperJunction Power MOSFET

Features

- Extremely Low Gate Charge
- Excellent Output Capacitance (C_{oss}) Profile
- Fast Switching Capability
- 100% UIS Tested, 100% R_g Tested
- Pb-free Lead Plating
- Halogen-free and RoHS-compliant
- AEC-Q101 Qualified for Automotive Applications

Product Summary

Parameter	Value	Unit
V_{DS}	650	V
$V_{GS(th)_{Typ}}$	3.5	V
I_D (@ $V_{GS} = 10V$) ⁽¹⁾	32	A
$R_{DS(ON)_{Typ}}$ (@ $V_{GS} = 10V$)	95	m Ω
E_{oss} @400V	7.8	μJ

Applications

- Switching Applications

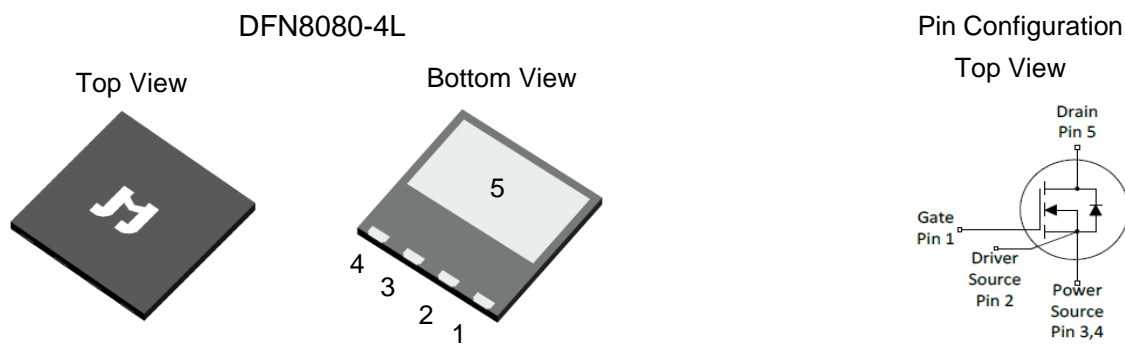

Ordering Information

Device	Package	# of Pins	Marking	MSL	T_J (°C)	Media	Quantity (pcs)
JMH65R110APLNFD-13	DFN8080-4	4	H65R110A	1	-55 to 150	13-inch Reel	3000

Absolute Maximum Ratings (@ $T_A = 25^\circ C$ unless otherwise specified)

Parameter	Symbol	Value	Unit
Drain-to-Source Voltage	V_{DS}	650	V
Gate-to-Source Voltage	V_{GS}	± 30	V
Continuous Drain Current ⁽¹⁾	I_D	$T_C = 25^\circ C$	32
		$T_C = 100^\circ C$	19.0
Pulsed Drain Current ⁽²⁾	I_{DM}	137	A
Avalanche Current ⁽³⁾	I_{AS}	10.0	A
Avalanche Energy ⁽³⁾	E_{AS}	500	mJ
Power Dissipation ⁽⁴⁾	P_D	$T_C = 25^\circ C$	250
		$T_C = 100^\circ C$	100
Junction & Storage Temperature Range	T_J, T_{STG}	-55 to 150	°C

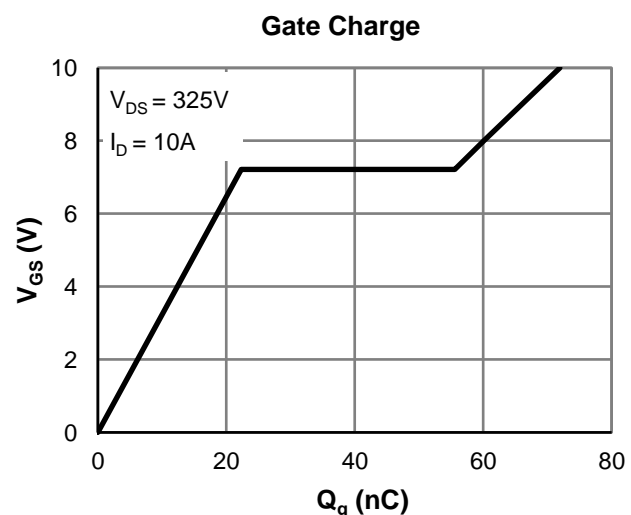
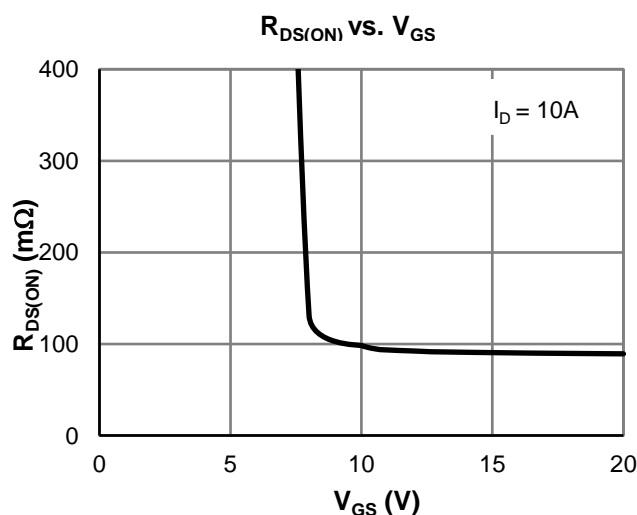



Electrical Characteristics (@ $T_J = 25^\circ\text{C}$ unless otherwise specified)

Parameter	Symbol	Conditions	Min.	Typ.	Max.	Unit
STATIC PARAMETERS						
Drain-Source Breakdown Voltage	$V_{(BR)DSS}$	$I_D = 250\mu\text{A}, V_{GS} = 0\text{V}$	650			V
Zero Gate Voltage Drain Current	I_{DSS}	$V_{DS} = 650\text{V}, V_{GS} = 0\text{V}$			10.0	μA
Gate-Body Leakage Current	I_{GSS}	$V_{DS} = 0\text{V}, V_{GS} = \pm 30\text{V}$			± 100	nA
Gate Threshold Voltage	$V_{GS(th)}$	$V_{DS} = V_{GS}, I_D = 250\mu\text{A}$	2.5	3.5	4.5	V
Static Drain-Source ON-Resistance	$R_{DS(on)}$	$V_{GS} = 10\text{V}, I_D = 10\text{A}$		95	110	m Ω
Diode Forward Voltage	V_{SD}	$I_S = 1\text{A}, V_{GS} = 0\text{V}$		0.75		V
Diode Continuous Current	I_S	$T_C = 25^\circ\text{C}$			10	A
DYNAMIC PARAMETERS ⁽⁵⁾						
Input Capacitance	C_{iss}	$V_{GS} = 0\text{V}, V_{DS} = 100\text{V}, f = 1\text{MHz}$		2869		pF
Output Capacitance	C_{oss}			93		pF
Effective output capacitance, energy related	$C_{o(er)}$	$V_{GS}=0\text{V}, V_{DS}=0\dots 400\text{V}$		97		pF
Effective output capacitance, time related	$C_{o(tr)}$	$I_D=\text{constant}, V_{GS}=0\text{V}, V_{DS}=0\dots 400\text{V}$		410		pF
Reverse Transfer Capacitance	C_{rss}	$V_{GS} = 0\text{V}, V_{DS} = 100\text{V}, f = 1\text{MHz}$		5.4		pF
Gate Resistance	R_g	$f = 1\text{MHz}$		2.2		Ω
SWITCHING PARAMETERS ⁽⁵⁾						
Total Gate Charge (@ $V_{GS} = 10\text{V}$)	Q_g	$V_{GS} = 0 \text{ to } 10\text{V}$ $V_{DS} = 325\text{V}, I_D = 10\text{A}$		72		nC
Gate Source Charge	Q_{gs}			22		nC
Gate Drain Charge	Q_{gd}			33		nC
Turn-On DelayTime	$t_{D(on)}$	$V_{GS} = 10\text{V}, V_{DS} = 325\text{V}$ $R_L = 32.5\Omega, R_{GEN} = 6\Omega$		29		ns
Turn-On Rise Time	t_r			30		ns
Turn-Off DelayTime	$t_{D(off)}$			77		ns
Turn-Off Fall Time	t_f			17.4		ns
Body Diode Reverse Recovery Time	t_{rr}	$I_F = 10\text{A}, di/dt = 100\text{A}/\mu\text{s}$		152		ns
Body Diode Reverse Recovery Charge	Q_{rr}	$I_F = 10\text{A}, di/dt = 100\text{A}/\mu\text{s}$		2.5		μC
Peak Diode Recovery Voltage Slope	dv/dt	$I_F \leq 2\text{A}, di/dt = 200\text{A}/\mu\text{s}, V_{DS} = 400\text{V}$		15.0		V/ns
MOSFET dv/dt Ruggedness	dv/dt	$V_{DS} = 0\dots 400\text{V}$		50		V/ns

Thermal Performance

Parameter	Symbol	Typ.	Max.	Unit
Thermal Resistance, Junction-to-Ambient	$R_{\theta JA}$	47	58	$^\circ\text{C}/\text{W}$
Thermal Resistance, Junction-to-Case	$R_{\theta JC}$	0.50	0.60	$^\circ\text{C}/\text{W}$

Notes:

1. Computed continuous current assumes the condition of T_{J_Max} while the actual continuous current depends on the thermal & electro-mechanical application board design.
2. This single-pulse measurement was taken under $T_{J_Max} = 150^\circ\text{C}$.
3. This single-pulse measurement was taken under the following condition [$L = 10\text{mH}, V_{GS} = 10\text{V}, V_{DD} = 50\text{V}$] while its value is limited by $T_{J_Max} = 150^\circ\text{C}$.
4. The power dissipation P_D is based on $T_{J_Max} = 150^\circ\text{C}$.
5. This value is guaranteed by design hence it is not included in the production test.

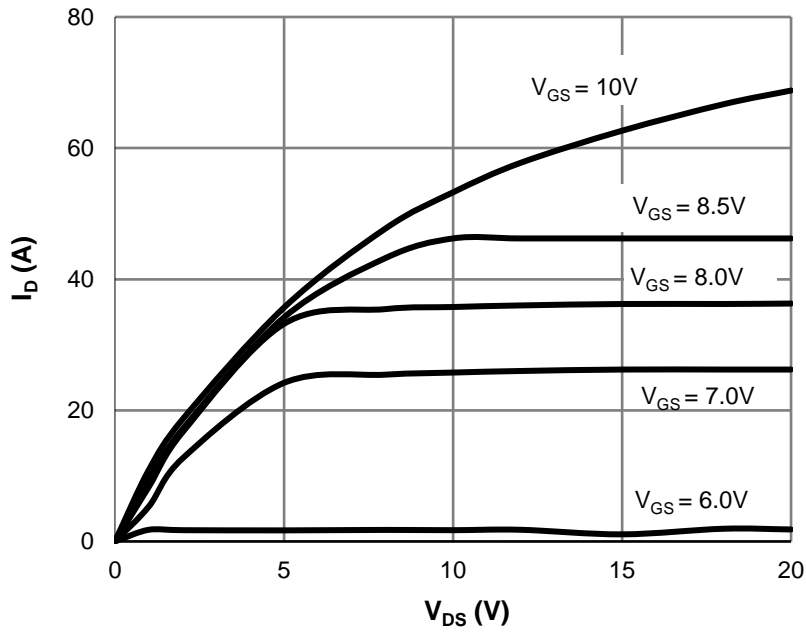
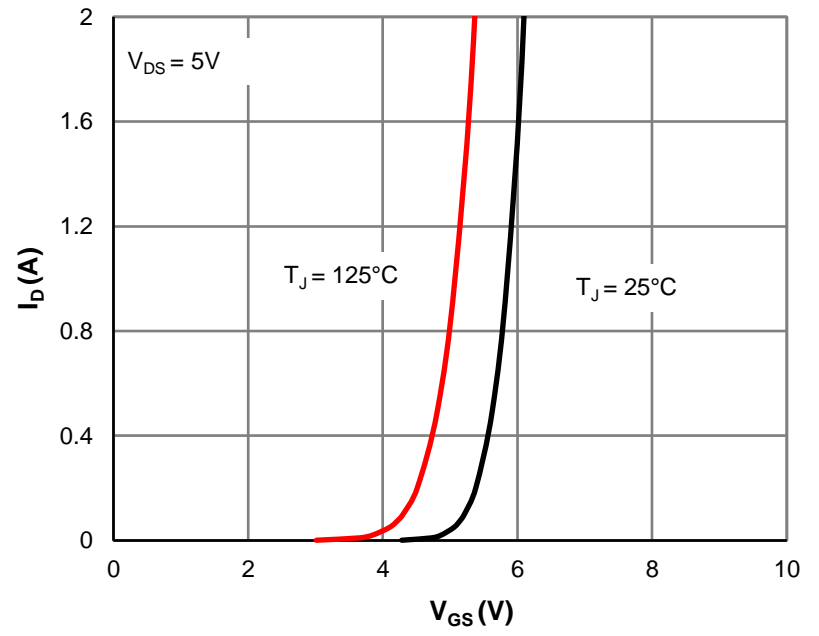
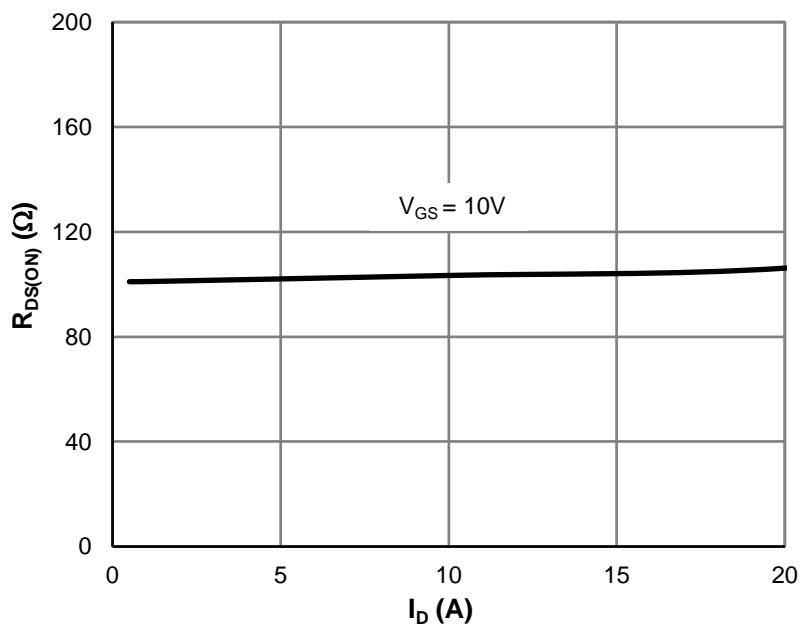
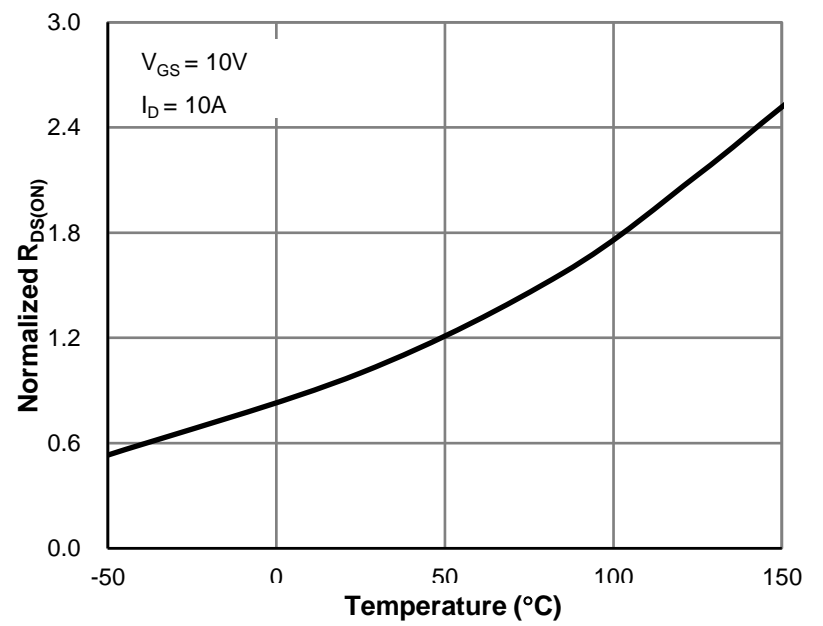
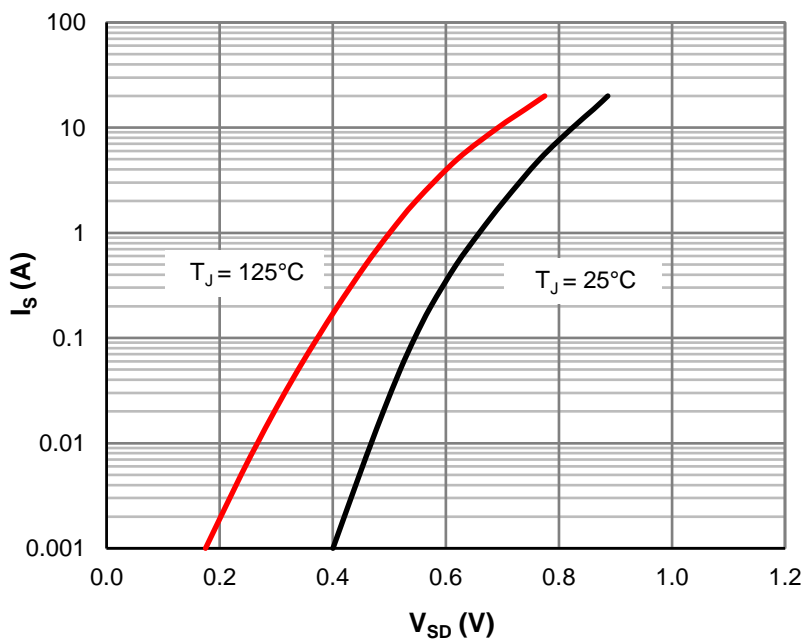
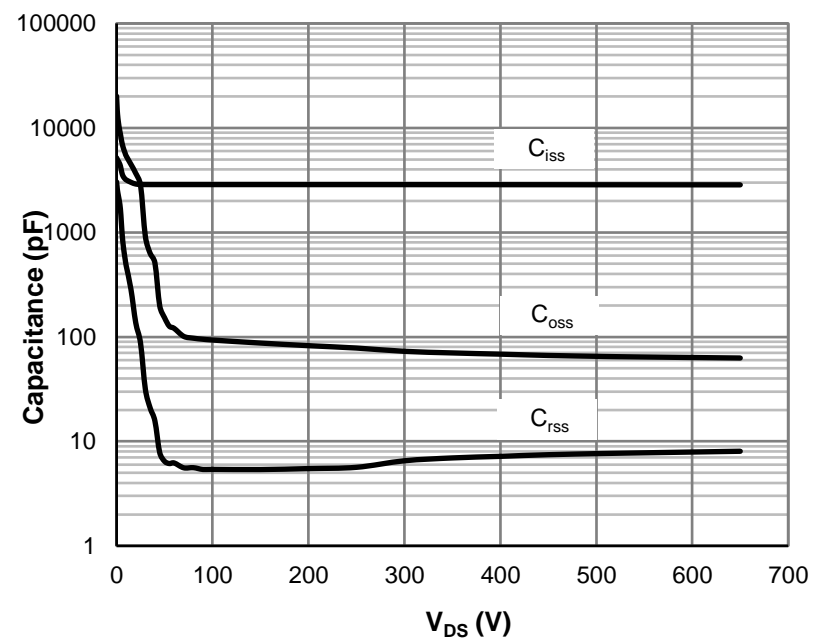
Typical Electrical & Thermal Characteristics

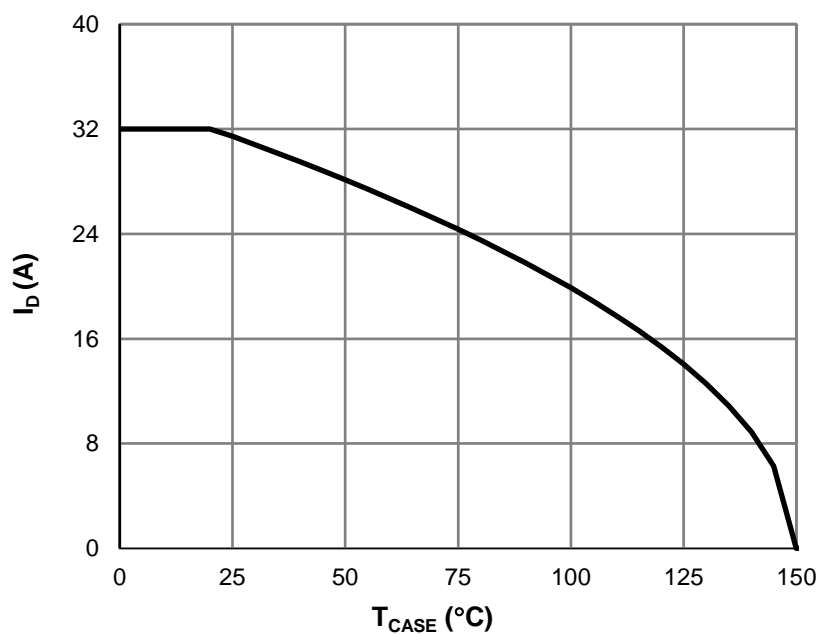
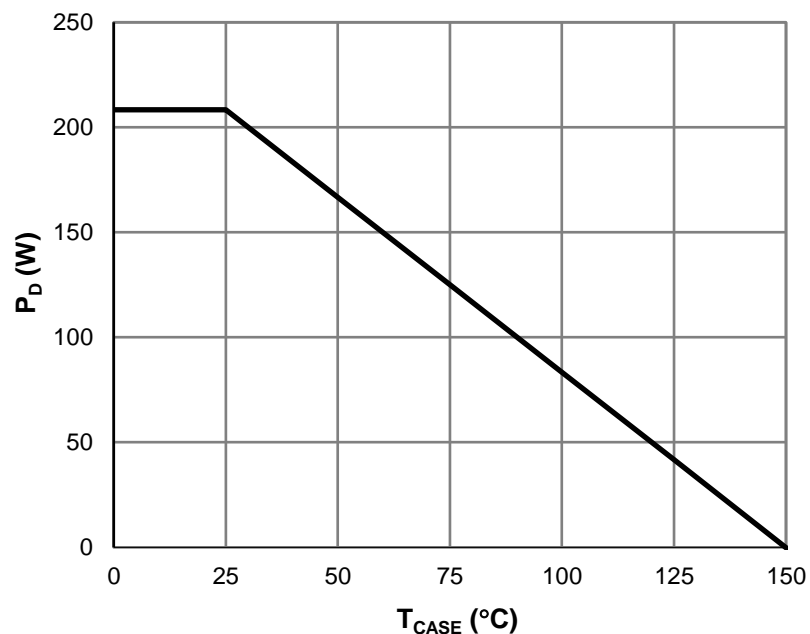
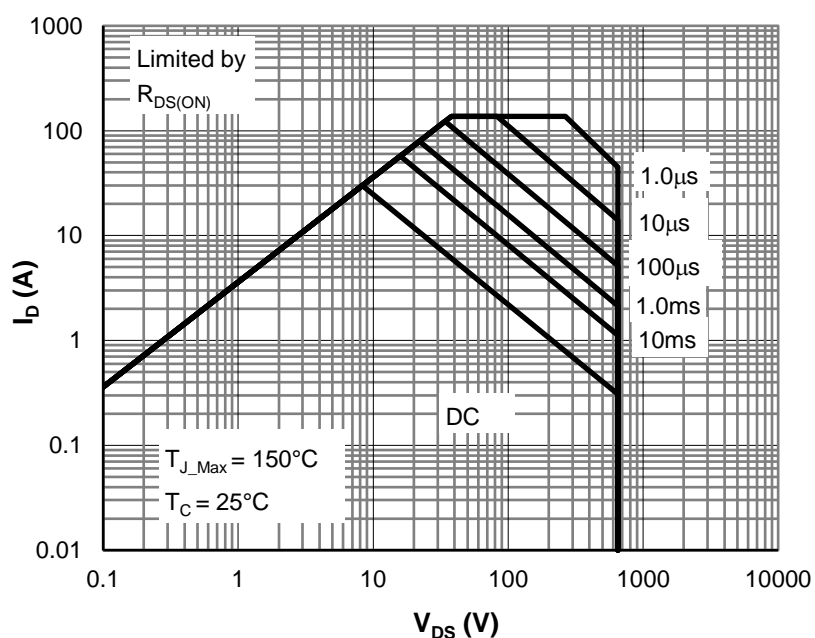
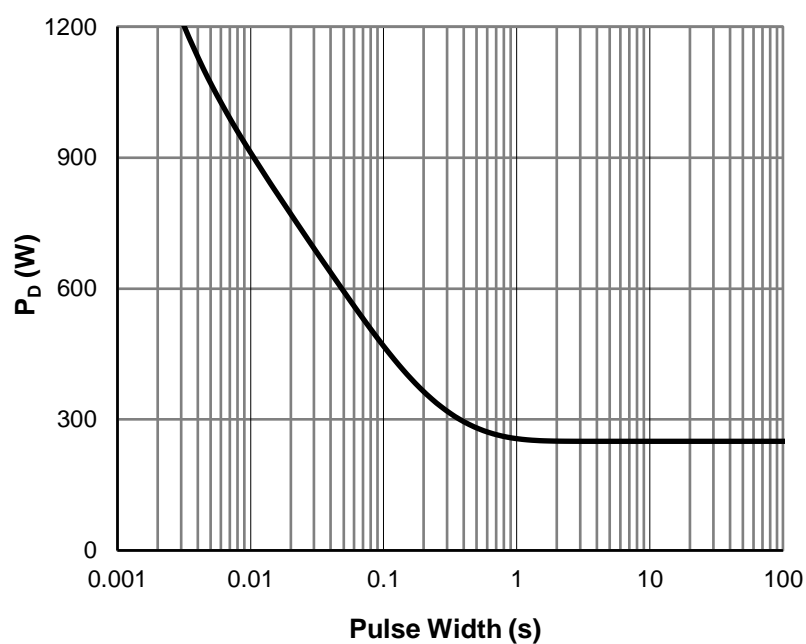
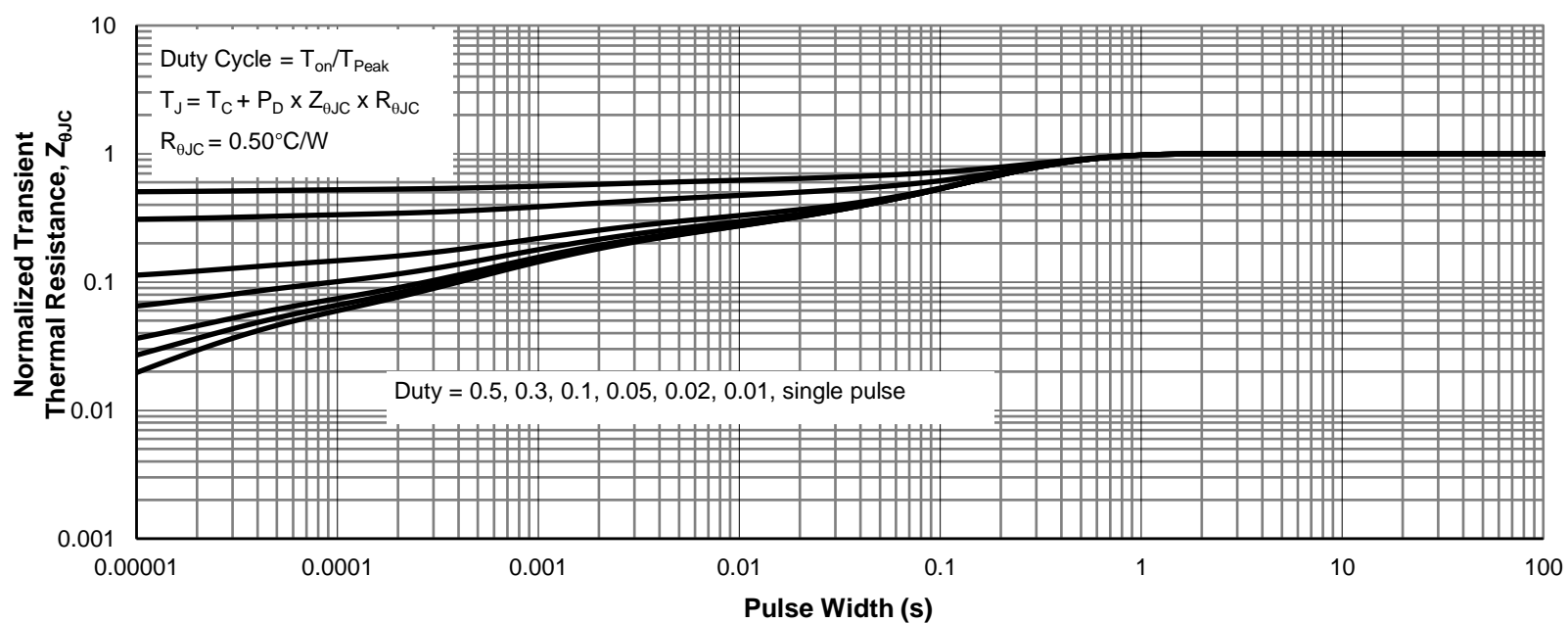
Figure 1: Saturation Characteristics

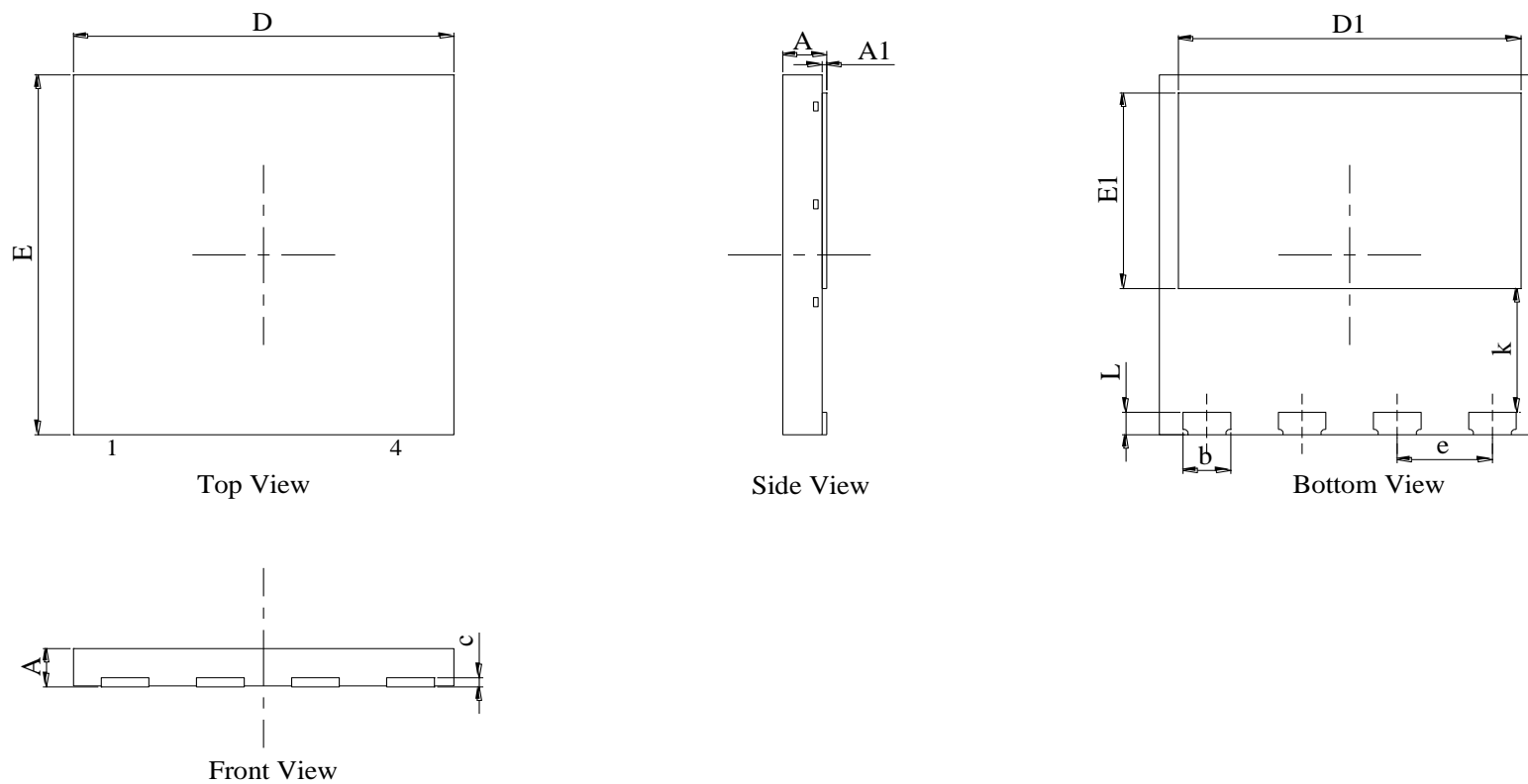
Figure 2: Transfer Characteristics

Figure 3: $R_{DS(ON)}$ vs. Drain Current

Figure 4: $R_{DS(ON)}$ vs. Junction Temperature

Figure 5: Body-Diode Characteristics

Figure 6: Capacitance Characteristics

Typical Electrical & Thermal Characteristics

Figure 7: Current De-rating

Figure 8: Power De-rating

Figure 9: Maximum Safe Operating Area

Figure 10: Single Pulse Power Rating, Junction-to-Case

Figure 11: Normalized Maximum Transient Thermal Impedance

DFN8080-4L Package Information
Package Outlines

DIM.	MILLIMETER		
	MIN.	NOM.	MAX.
A	0.85	0.90	0.95
A1	--	--	0.05
b	0.95	1.00	1.05
c	--	0.20	--
D	7.90	8.00	8.10
D1	7.10	7.20	7.30
E	7.90	8.00	8.10
E1	4.25	4.35	4.45
L	0.40	0.50	0.60
k	2.75		
e	2.00 BSC		

Recommended Soldering Footprint
